



BEAMS & TIMBER

HIGH GRADE TIMBER PRODUCTS



**PRODUCT
CATALOGUE**

Celebrating 20+ years helping property owners
make a lasting first impression



OUR PRODUCTS



Complement the overall aesthetic with painting or staining
150mm x 150mm / 150mm x 50mm x 1.8m / 0.9m



Great example of feature background planting
150mm x 150mm / 150mm x 50mm x 2.0m / 1.2m



Create flowing curves and lines
150mm x 150mm / 150mm x 50mm x 2.0m / 1.2m

WHY CHOOSE US?



CUSTOMER FOCUSED

Everything we do is dedicated to achieving the ideal outcome you envision



UNMATCHED QUALITY

We prioritize excellence, from carefully selecting raw materials to implementing thorough quality control measures



EXCEPTIONAL SERVICE

We aim to consistently provide exceptional customer service through our expert advice and prompt, thorough communication



BEST VALUE

We deliver what we believe to be the best value products in our market, considering the timber grade and cost over the products lifetime



GREAT SUPPORT

We offer excellent after-sales service and support for any assistance you may need



GUARANTEED SATISFACTION

If your experience with us is anything less than 5 star, we will do whatever it takes to achieve that level of satisfaction

WE STAND BY OUR PRODUCTS 100%

THINGS TO CONSIDER WHEN CHOOSING YOUR FENCE

PURPOSE

It's worth taking the time to consider your goals for the fence. Is it for aesthetic enhancement? Do you need to contain pets, animals, or livestock? Is it to define your boundary, meet security requirements, or create privacy? Do you want to make a statement with your entrance way? Understanding your ideal outcome and communicating it clearly will help us deliver you the end result you will be happy with for many years to come.

STYLE AND DESIGN

Consider the architectural style of your home and the surrounding landscape when selecting a fence style to complement the overall aesthetic. Our Interlock post and rail fencing is ideal if you prefer not to create a solid barrier. It is perfect for properties with a view or beautiful landscaping you want to showcase, adding an elevated elegance to traditional post and rail fencing.

HEIGHT AND REGULATIONS

Check local regulations regarding fence height, setback requirements, and any other restrictions that may apply. Our Interlock Post and Rail fencing comes in a variety of heights, from 0.6m to 1.2m above ground in our standard range. We also offer custom options to provide endless possibilities. Contact us to discuss your ideas and requirements.

COST VS VALUE

It's important to consider the upfront cost versus long-term value. As the saying goes, you get what you pay for, and this is especially true with timber. Ideally, fencing is a one-time investment, so it's worth spending more initially to get quality materials that last. This often saves money in the long run, resulting in a lower annual cost over the life of the fence.

MATERIALS

Choose the right materials based on your needs, budget, and maintenance preferences. Common options include wood, vinyl, metal, and composite materials. All our Interlock post and rail fences are made from 100% sustainably grown Radiata Pine, offering a pleasing natural aesthetic, low maintenance requirements, and great longevity.

INTERLOCK FENCING FEATURES

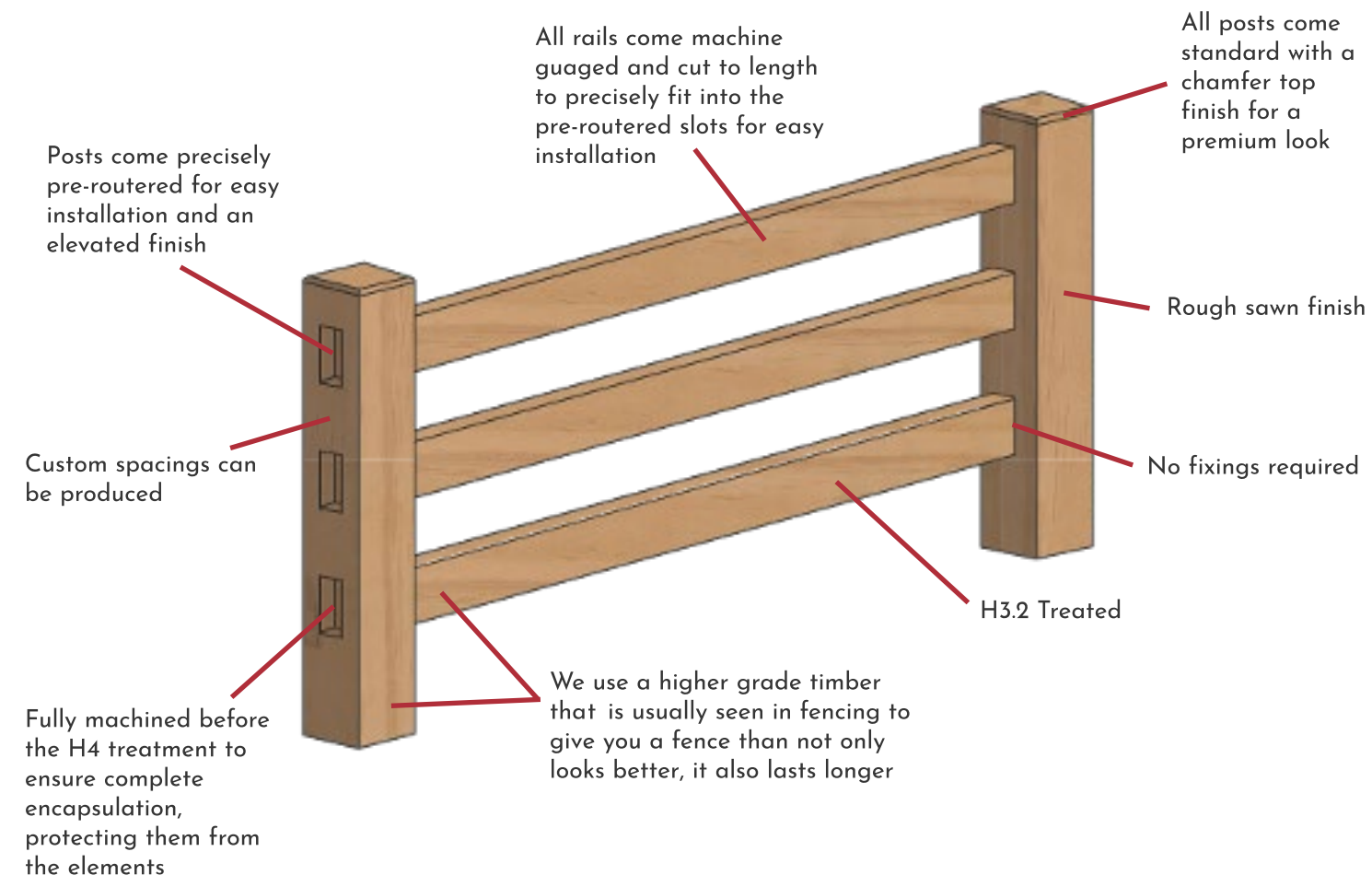

BTD POST & RAIL INTERLOCK FENCING OPTIONS

POST SIZE

Our posts come in nearly any size and length you could desire. All posts feature a rough sawn finish with a 20mm chamfer top detail (a flat top is also available). The posts are fully machined before the H4 treatment to ensure complete encapsulation, protecting them from the elements.

See our post sizes below, available in lengths up to 6m. Consider the aesthetic you want: simple and elegant with smaller posts, or robust and statement-making with larger posts. Additionally, consider if you need larger posts for your entrance or to hang gates.

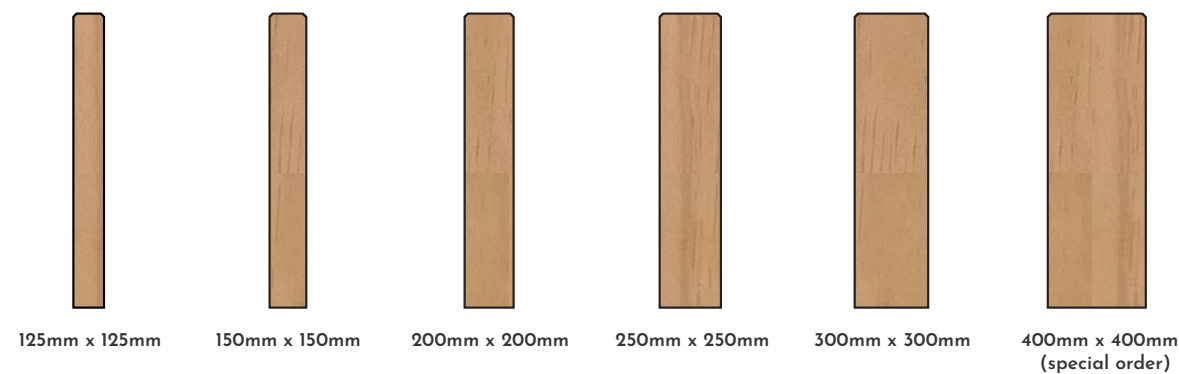

RAIL SIZE

All our rails are manufactured from higher-grade timber than what is typically used in fencing, setting us apart from the competition, you can visually see the difference. We recommend using rail lengths no longer than two meters to minimize issues with twisting, bending, or warping, and to achieve a nicely proportioned look, avoiding a stretched-out appearance.

The 150mm x 50mm rails are machine-gauged on all four sides to fit precisely into the pre-routed slots in the posts. The 200mm x 50mm rails are machined on three sides, allowing for a rough sawn finish on the front, providing a more rustic look when used with larger posts.

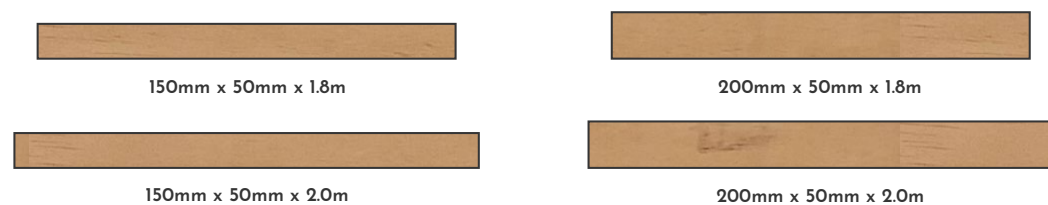

Our fencing is available in 1-rail, 2-rail, 3-rail, and 4-rail options, making our system versatile for a wide variety of applications. The different rail configurations cater to diverse needs.

The 1-rail system serves as a low barrier, ideal for parks and reserves; the 2-rail system provides a more pronounced barrier while maintaining excellent visibility; the classic and stylish 3-rail system is multipurpose; and the 4-rail system is perfect for creating a safe enclosure for pets, animals, livestock or our most pronounced property fence line.

These are just a few examples of the various applications across our range. You can find the specifications for each option at the end of our Interlock system section.

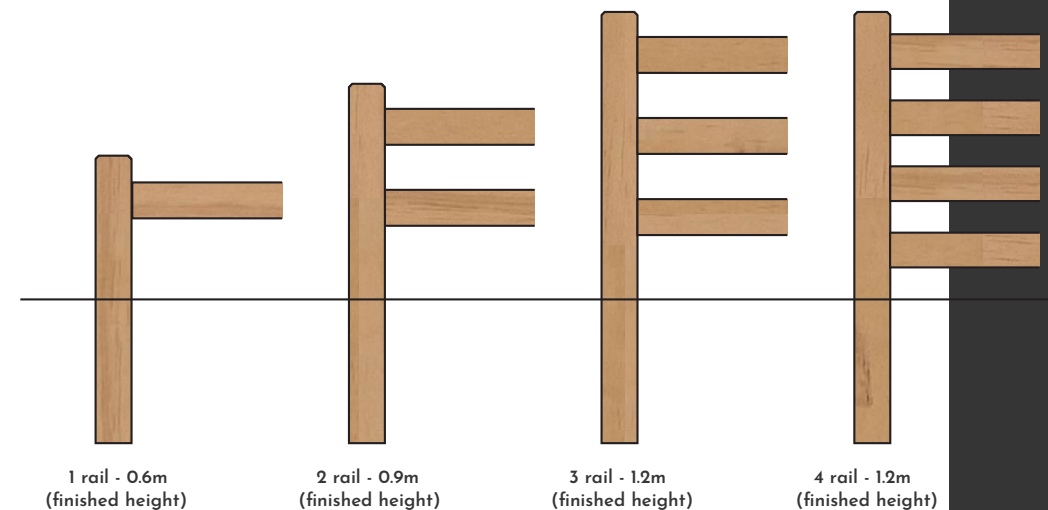

Our pre-routed post types allow for any fence layout you can imagine. With the flexibility for rails to fit into the pre-routed slots at a wide variety of angles. Changes in direction or variations in ground elevation or slopes can be handled with ease.

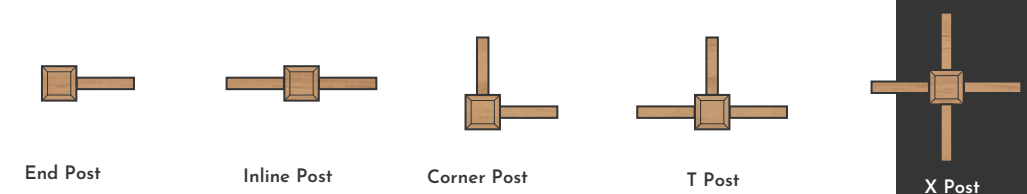

NO. OF RAILS

POST TYPES

4 RAIL SYSTEM



Matamata - full class running inside & outside the property
150mm x 150mm / 150mm x 50mm x 2.0m / 1.2m

The robust and stylish stock safe solution



The four rail system is great for pets & stock
125mm x 125mm / 150mm x 50mm x 2.0m / 1.2m



Cambridge Stud - Custom four rail
150mm x 150mm / 150mm x 50mm x 1.8m / 1.5m

Our four-rail system provides our most substantial and robust solution.

Our most pronounced fence line, ideal for containing livestock, animals or pets.

This system also offers additional height above ground using the 200mm x 50mm rails.

3 RAIL SYSTEM

An elevated classic to set your property apart



St Kilda, Cambridge - stylish & timeless in white
150mm x 150mm / 150mm x 50mm x 2.0m / 1.2m

Our three-rail system is the most popular in our range.

It offers the classic post-and-rail look with an elevated finish, thanks to our higher-grade timber, finishing detail, and interlocking system.

Can also provide a stock or pet safe solution using a wire under bottom rail or our larger rails.



Warkworth Showgrounds - robust look with larger rails
150mm x 150mm / 200mm x 50mm x 1.8m / 1.2m



High Grove, Matamata - awesome finish with planting back drop
150mm x 150mm / 150mm x 50mm x 2.0m / 1.2m

HEAR FROM OUR CUSTOMERS

Our 5-star Google rating reflects our commitment to our customers!

GOOGLE REVIEW ★★★★★

We worked with Beams & Timber last year to do a custom fence line for our rural property in Silverdale and they were a pleasure to deal with - very helpful & informative and did their best to cater to our needs and we've ended up with a very unique and impressive entrance way that everyone comments on! We will be using them in future projects.

Straka Construction & Earthmoving LTD

GOOGLE REVIEW ★★★★★

Great product. Took me 2 years to finally order it but the results that it gives our property is superb. I knew from the outset that it was worth it and it was. The neighbourhood loves it as they think it makes everybody look good hence higher values. The team at Beams and Timber were always helpful and patient.

Mylam Sloan



GOOGLE REVIEW

★★★★★

We have recently built a new house on a small block and we could not decide what sort of fence to put in. The lovely staff at Beams & Timber were able to give us suggestions and provide us with addresses where we could see completed fences. We went with their recommendations and we could not be happier. A pleasure to work with this company.

Tracy Thompson

GOOGLE REVIEW ★★★★★

Our new fence is absolutely fabulous, it just finishes the property off. The best fencing system around in our opinion. The team at Beams and Timber could not have been more helpful. Graeme Ross (Matamata) put the fence up and did a great job at a reasonable price.

Julie Earl



GOOGLE REVIEW ★★★★★

The team at Beams and Timber were great to deal with, advise was great also delivery and supplying a fantastic product. We did 200 metres of three rail and used one of their suggested installers. Best move I ever did, 200 metres dead straight and correctly installed. Highly recommend this company.

Gerry Watkinson

just a few of our many reviews....



Stunning in the morning sun
125mm x 125mm / 150mm x 50mm x 2.0m / 0.9m

Perfect for reduced obstruction to views



Nice and Sturdy using bigger posts and rails
250mm x 250mm / 200mm x 50mm x 2.0m / 0.9m



Also looks great in residential settings
150mm x 150mm / 150mm x 50mm x 2.0m / 0.9m

Our two-rail system is the second most popular in our range.

With a lower cost and height above ground, it is perfect for defining your boundary while reducing obstruction to views.

A clean minimalistic look that will have your neighbours green with envy



Hamilton International Airport - robust low barrier
150mm x 150mm / 200mm x 50mm x 2.0m / 0.8m



Glenview - ideal separation between footpath and shared driveway
150mm x 150mm / 200mm x 50mm x 2.0m / 0.6m

The ideal low profile, cost effective boundary defining option

Our 1-rail system is the lowest profile fence and most cost effective in our range. Also the fastest and easiest to install.

It's perfect for car parks, recreational areas, and commercial use. Providing a barrier to keep vehicles, motorcycles and cyclists out while providing an easy step over for pedestrians and clearly defining your boundary.

1 RAIL SYSTEM



STANDARD SPECIFICATIONS

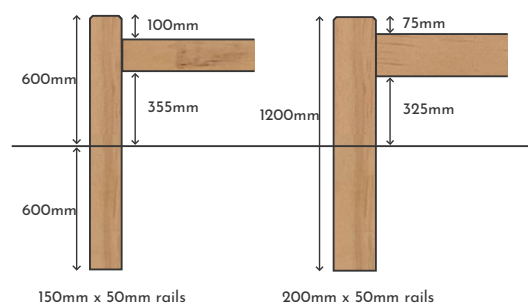
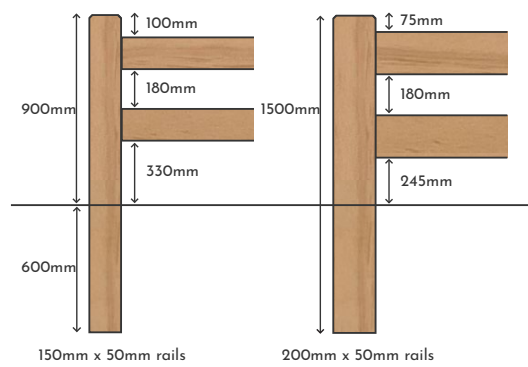
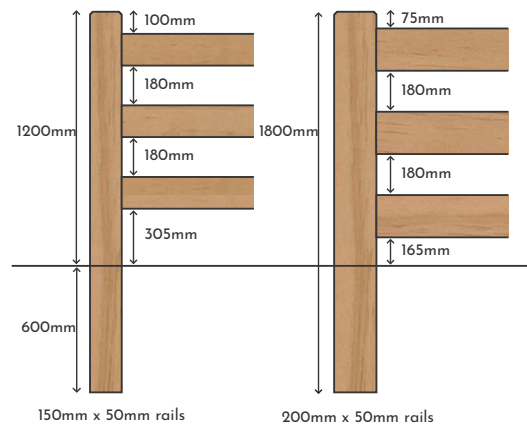
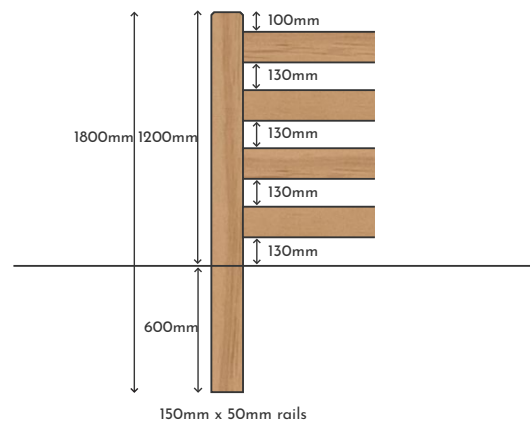

Custom spacing available - talk with us



GOOGLE REVIEW ★★★★★

We required a new front boundary fence on our lifestyle block in South East Auckland and decided a timber interlocking fence would probably look the best. I started corresponding with Helen at Beams and Timber and with her help we decided on the fence we wanted. It was manufactured by them in the time frame promised.

I installed it myself and the job was made easier because of the high quality of the timber supplied. The beams and posts were all perfectly straight and the slots in the posts were cut out to perfectly fit the rails. I over ordered a few items and Pete was happy for me to return them.

We couldn't be happier with the end result and would thoroughly recommend Beams and Timber to anyone wanting a top quality fence.

Murray Draper

CUSTOM INTERLOCK



Known as the "Speights" fence after the original customer
150mm x 150mm / 150mm x 50mm x 2.0m / 1.2m



Solid finish variation to our original system
200mm x 200mm / 150mm x 50mm x 2.0m / 1.2m



A truly impressive fence in person
200mm x 200mm / 125mm x 125mm x 2.0m / 1.5m

Let us help you realise your vision

Looking for something unique or have special requirements? Our Interlock system is exceptionally versatile. We can custom-make nearly anything you can imagine.

Talk with us today about your vision, and we can help make it a reality.

Custom made to
your needs



Matakana gate looking sharp in stain finish
150mm x 150mm / 200mm x 50mm x 2.0m / 0.9m

We manufacture a range of gates to complement your Interlock fence or create a stylish entranceway.

With various timber sizes and custom-made to your specifications, we have the ideal gate for a variety of uses and environments.



Waiheke gate suits just about any fence
250mm x 250mm / 200mm x 50mm x 2.0m / 0.9m



Classic look with the Russell gate
125mm x 125mm / 150mm x 50mm x 2.0m / 0.9m

BTD GATE STYLES

WAIHEKE

Gate Types Double Gate Set / Pedestrian Gate
 Timber Size 200 x 25mm
 Length 1200 - 2400mm
 Height 1100mm

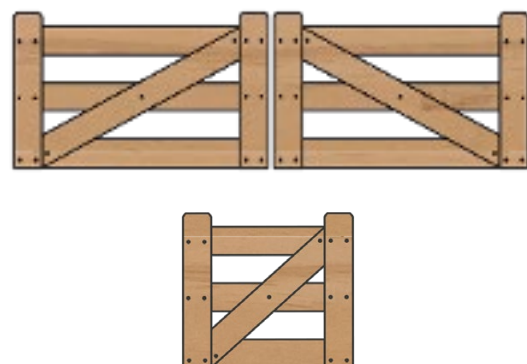

MATAKANA

Gate Types Double Gate Set / Pedestrian Gate
 Timber Size 200 x 25mm
 Length 1200 - 2400mm
 Height 800mm

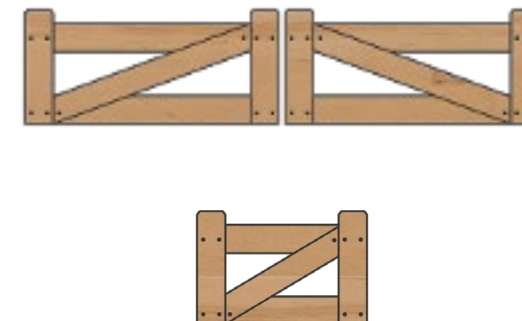

CHRISTCHURCH

Gate Types Double Gate Set / Pedestrian / Single Gate
 Timber Size 150 x 25mm
 Length 1200 - 4200mm
 Height 1100mm

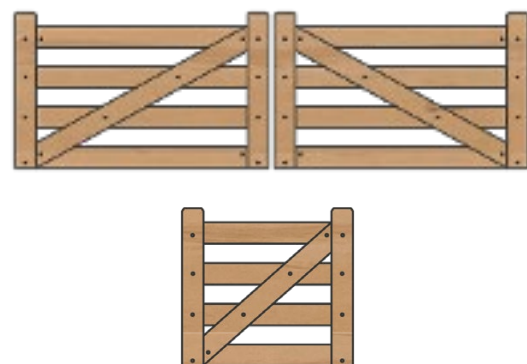

RUSSELL

Gate Types Double Gate Set / Pedestrian / Single Gate
 Timber Size 150 x 25mm
 Length 1200 - 4200mm
 Height 1100mm

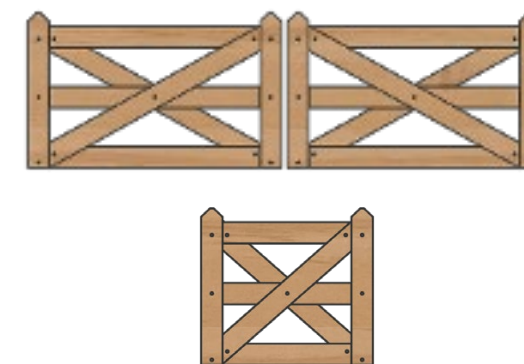

NAPIER

Gate Types Single Gate
 Timber Size 150 x 25mm
 Length 3000 - 4200mm
 Height 1100mm

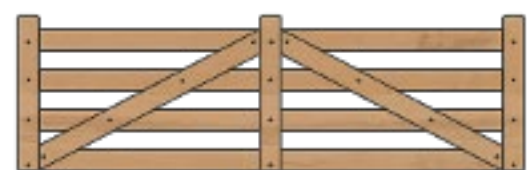

HASTINGS

Gate Type Single Gate
 Timber Size 150mm x 25mm
 Length 3000 - 4200mm
 Height 1100mm

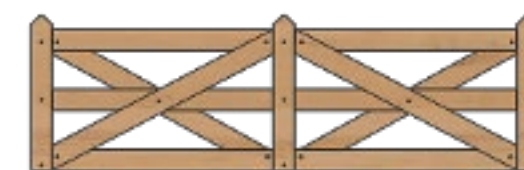

TAUPO

Gate Type Single Gate
 Timber Size 150 x 25mm
 Length 3000 - 4200mm
 Height 1100mm

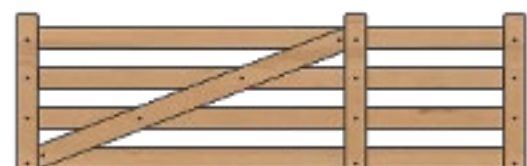

WALTON

Gate Type Single Gate
 Timber Size 100 x 25mm
 Length 3000 - 4200mm
 Height 1100mm

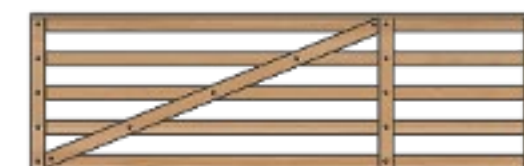

BTD GATE STYLES

PAIHIA

Gate Types Double Gate Set / Pedestrian / Single Gate
 Timber Size 150 x 25mm
 Length 1200 - 4200mm
 Height 800mm

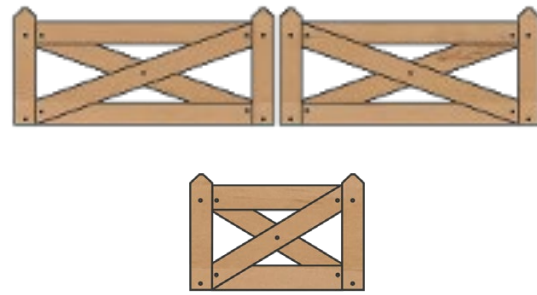

KERIKERI

Gate Type Double Gate Set
 Timber Size 150 x 25mm
 Length 2 x 2400 - 3000mm
 Height 1700mm (outer) 1100mm (inner)

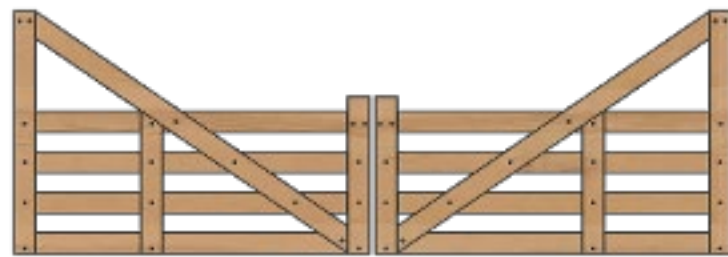

KINLOCH

Gate Type Double Gate Set
 Timber Size 150 x 25mm
 Length 2 x 2100 - 2700mm
 Height 1400mm (outer) 1100mm (inner)

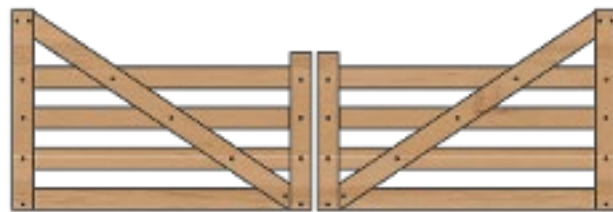

TAURANGA

Gate Type Double Gate Set
 Timber Size 100 x 25mm
 Length 2 x 2100 / 2400mm
 Height 1500mm (outer) 1100mm (inner)

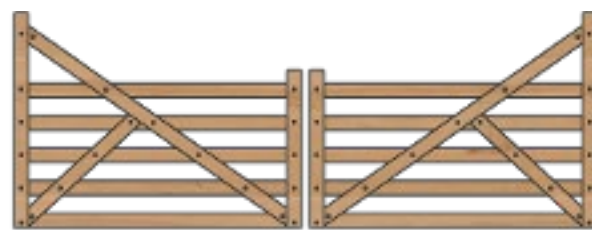

CROMWELL

Gate Type Double Gate Set
 Timber Size 100 x 25mm
 Length 2 x 2100 / 2400mm
 Height 1500mm (outer) 1100mm (inner)



GATE HARDWARE

STRAP HINGES FOR 3" GATE



Finish Zinc / Epoxy Black
 Sizes M20 x 300 / 375mm

THROUGH POST GUDGEON



Finish Zinc / Epoxy Black
 Sizes M20 x 250 / 300 / 350mm

LOCK THROUGH GUDGEON



Finish Zinc / Epoxy Black
 Sizes M20 x 250 / 300 / 350mm

SCREW GUDGEONS LONG PIN



Finish Zinc / Epoxy Black
 Sizes M20 x 100mm

SCREW GUDGEONS SHORT PIN



Finish Zinc / Epoxy Black
 Sizes M20 x 100mm

THROW OVER LATCHES



Finish Zinc / Epoxy Black
 Sizes 75mm



Great for businesses to make a strong first impression
200mm x 200mm / 200mm x 50mm x 2.0m / 1.2m



Stand out with super sized 400mm x 400mm high top posts
150mm x 150mm / 150mm x 50mm x 2.0m / 1.2m



Looking dapper lining the longer driveway
150mm x 150mm / 150mm x 50mm / 1.2m

Create an entrance way to impress

Create impressive entrance ways by combining our fencing with large posts (high top options available) and gates, either manufactured by us or sourced elsewhere.



Super solid bollards Mission Bay
300mm x 300mm x 0.9 / Chamfer, Collar / 0.45m



New subdivision Glenview, Hamilton
150mm x 150mm x 1.2m / Pointed, Collar / 0.6m

Precisely
manufactured to
your requirements

All bollards are
manufactured from high
grade Radiata Pine with
rough sawn or machine
gauged finish, uni-diameter
and square options.

Choose from our in stock
styles or we can
manufacture to your
custom design.



Hamilton Rd, Cambridge
150mm uni-diameter / Dome / 0.6m

BTD BOLLARDS

BOLLARD LENGTHS

Below are the standard lengths we offer, we can also produce to any custom specifications required. The most popular length is 1200mm, followed by 900mm and 1500mm. There is no set in-ground depth for bollards; we recommend setting 1/3 to 1/2 of the bollard in the ground.

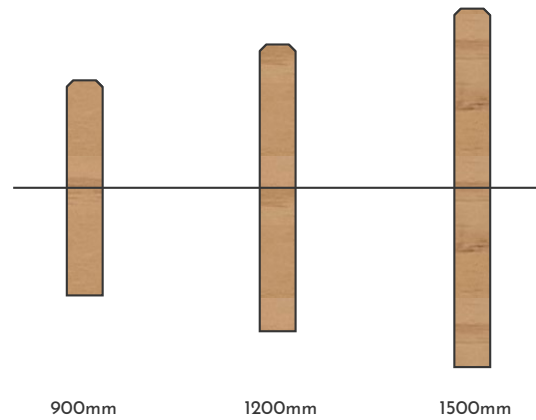

SQUARE BOLLARD SIZES

We have a good range of sizes available below. Our 150mm x 150mm size with a machine gauged finish is the most widely used for bollards.



ROUND BOLLARD SIZES

The size options are shown below for uni-diameter bollards.



SQUARE BOLLARD SPECIFICATIONS

There are endless options for the look and finish of timber bollards. Below are our standard top profile and detail finish options that we can produce. Holes for rope or chain can also be added to any of our bollard variations. We can custom-make nearly any bollard, although there are setup fees for variations from our standard specifications shown below.

We recommend using one of our in-stock styles. Custom styles can take weeks to fit into our production schedule, causing unwanted delays for initial orders or replacements, which can become costly.

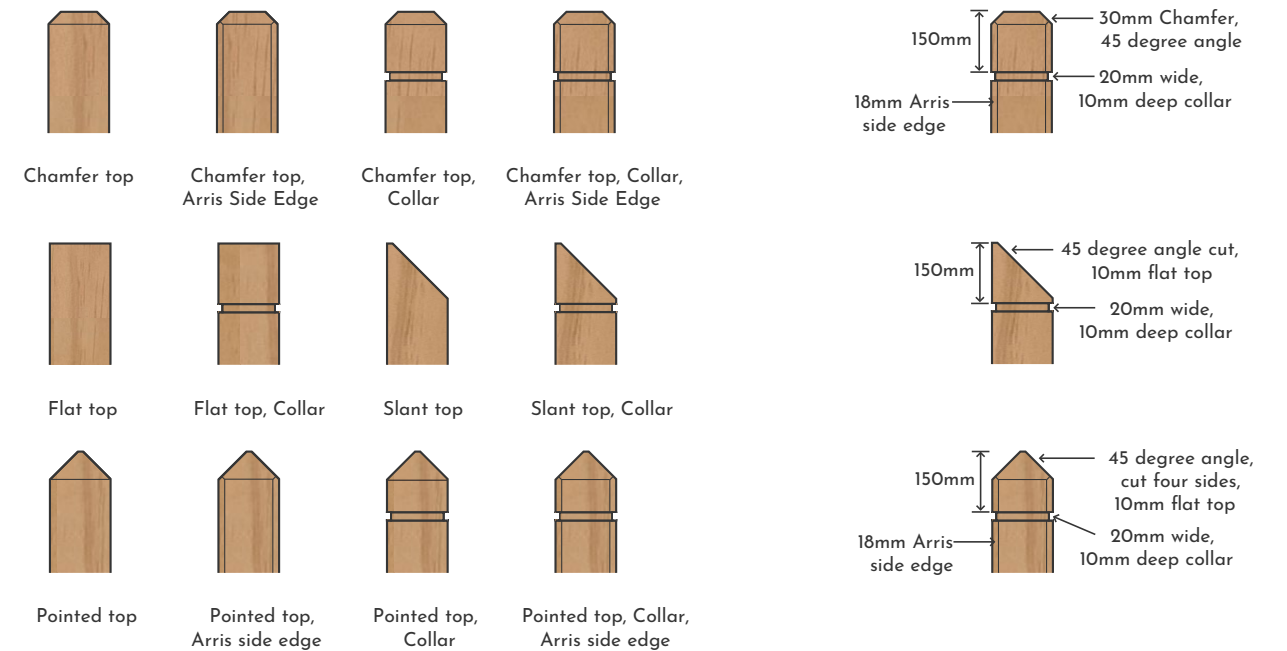

ROUND BOLLARD SPECIFICATIONS

Shown below are the styles and specifications that can be ordered. Slant and bullnose tops can also be manufactured. Holes for rope or chain can be added to any of the available styles. We only hold stock in the standard 150mm dia x 1.2m dome top bollard, all other styles are made to order.

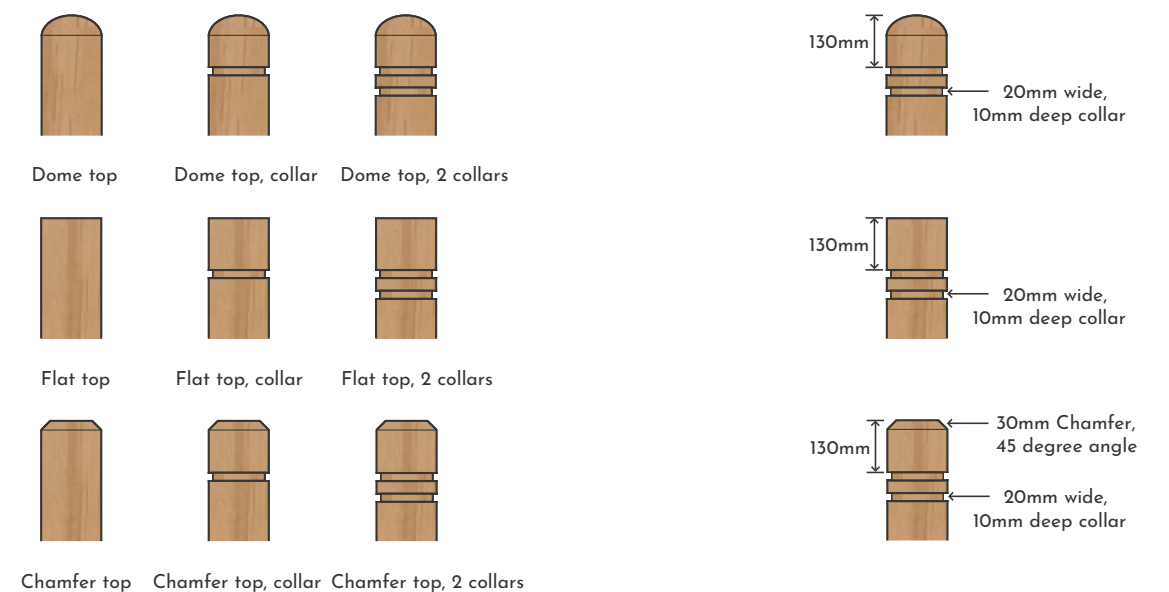

BOLLARD ACCESSORIES



Robust bollard barrier
250mm x 250mm x 1.2m / Chamfer / 0.6m



Ideal coastal feel finish with the rope
150mm uni-diameter / Dome / 0.6m



Pokeno subdivision
150mm x 150mm x 1.2m / Chamfer, 2 x Collar / 0.6m

CONCRETE SURROUNDS

We offer pre-cast mowing concrete surrounds for our bollards. These are available in 125mm and 150mm for square bollards, and 150mm and 180 / 200mm for round bollards.

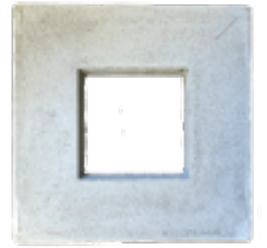

REMOVABLE SLEEVES

Need vehicle access to an area sectioned off with bollards? Our removable sleeves are the perfect solution. Available for 150mm bollards in both round and square, simply concrete in the sleeve, attach the supplied hasp to the bollard, fit it through the slot in the lid, and secure it with a padlock.

SPECIALISED TIMBER

We also supply specialised timber not commonly found at merchants. We offer large squares in 125mm, 150mm, 200mm, 250mm, and 300mm in both standard and longer lengths, with H3.2, H4, and H5 treatment options. We provide large quantities of timber at competitive prices in a variety of grades and sizes.

In addition to the sizes pictured, we can produce custom sizes from our timber stock for multiple pieces. All the sizes below are available in a rough sawn finish. We can machine gauge any timber sizes up to a maximum of 350mm wide and 160mm thickness. With treatment options of H3.2, H4, and H5, we have you covered for a wide range of uses.



Create beautiful outdoor architectural structures
150mm x 150mm

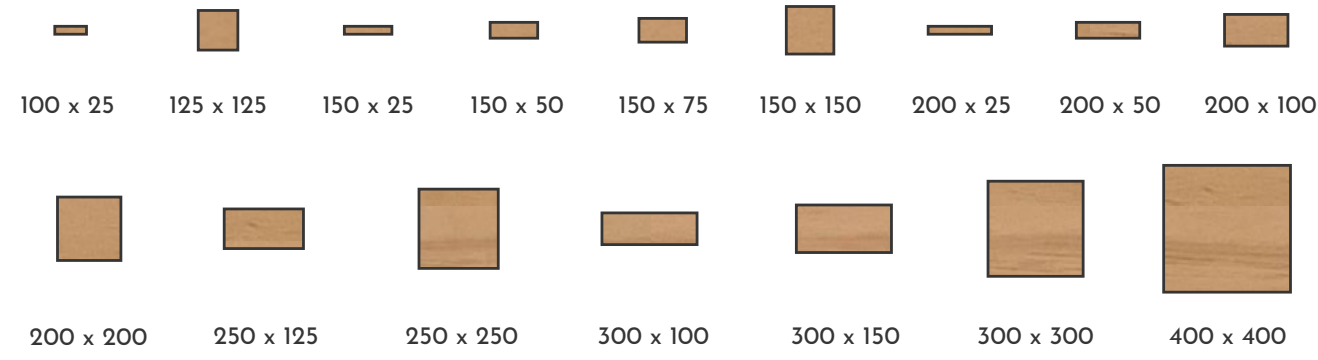

Extend our fencing system to create feature archways
150mm x 150mm



Impressive garden feature using large squares
250mm x 250mm



Get in touch today
for a free quote!

09 236 9916

sales@beamsandtimber.co.nz

34 Bollard Rd, Tuakau